

Data Sheet



Article number: 54810642031

Description: 2 hole Flange Unit TP-SUCFL203 for shaft $\varnothing 17\text{mm}$
Insert stainless steel, housing Thermoplastic black

Measures

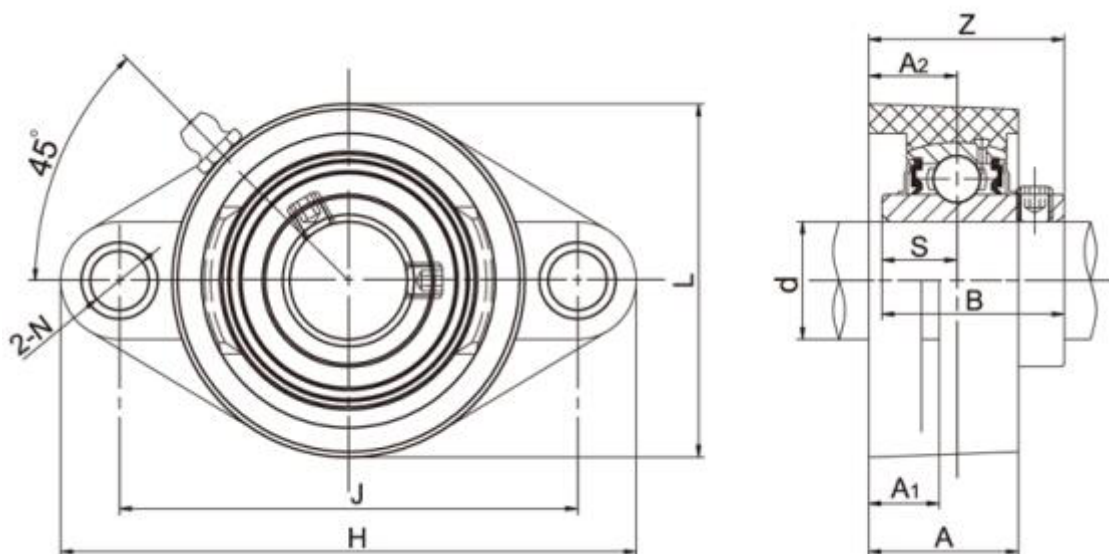

A = 26.5	L = 65
A1 = 14	N = 11
A2 = 15.4	S = 12.7
B = 31	Z = 33.7
Bolt = M10	
d = 17	
H = 113	
J = 90	